

4.0V~30V输入，3.5A同步降压变换器

4.0~30V Input, 3.5A, Synchronous Buck Converter

■ FEATURES

- 3.5A converter with 100mΩ and 60mΩ FETs
- Fast transient response with minimum external components
- Input voltage range: 4.0V~30V
- Output voltage range: 0.8V~18V
- Pulse skip mode to keep high efficiency in light load
- 600kHz switching frequency
- Shutdown current: $\leq 1 \mu\text{A}$ (typical)
- Soft start and start delay with pre-biased output voltage
- Cycle-by-cycle over current limit
- Hiccup-mode over current protection
- Non-latching Undervoltage protection and Thermal Shutdown protection
- Enable pin
- Packages: Pb-free Packages, ESOP8, SOT23-6L
- 3.5A降压，内置100mΩ和60mΩ功率管
- 于快速瞬态响应，外部元器件少
- 输入电压范围：4.0V~30V
- 输出电压范围：0.8V~18V
- 脉冲跳跃模式使得轻载下高效率
- 600kHz开关频率
- 关断电流 $\leq 1\mu\text{A}$ (典型值)
- 软起动，输出预先有电压时有启动延迟
- 逐周期过流检测限制
- 打嗝模式过流关断
- 欠压保护、过热关断保护，不锁定可自动恢复
- 具有使能pin
- 无铅封装，ESOP8, SOT23-6L

■ APPLICATIONS

- 5V, 12V or 24V power rail applications
- TV
- Consumer electronics
- Industrial power supplies
- 5V, 12V或24V电源轨
- 嵌入式系统
- 消费电子
- 电视
- 机顶盒
- 工业电子

DESCRIPTION

The HT7723x is a 3.5A, step-down, buck converter with minimum external components and low shutdown current.

The device delivers a fast transient response with both low ESR (polymer) and ultra-low ESR (ceramic) output capacitors, and no external compensation is needed.

The device operates in Pulse Skip Mode when in light load with high efficiency.

The HT7723x is available in ESOP8, SOT23-6L packages.

HT7723x 是一款 3.5A 降压转换器，具有最少的外部元件和低关断电流。

该器件具有快速瞬态响应的特点，输出电容器采用低 ESR（聚合物）或超低 ESR（陶瓷），无需外部补偿。

该器件在轻载时以脉冲跳跃模式工作，达到高效。

HT7723x 采用ESOP8, SOT23-6L 封装。

TYPICAL APPLICATION

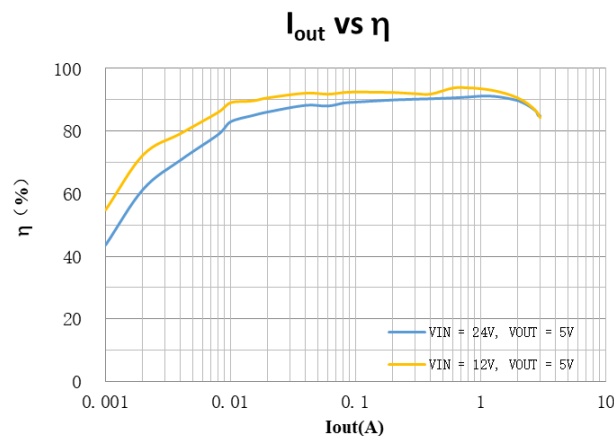
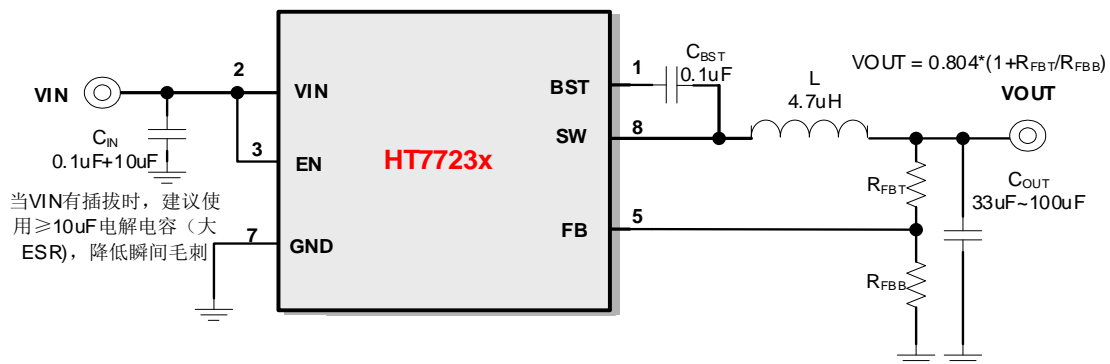

ORDERING INFORMATION

Part Number	Package Type	Marking	Operating Temperature Range	Shipping Package / MOQ
HT77231SPER	ESOP8 (SPE)	HT77231 YYYMAAB ¹	-40°C ~ 125°C	Tape and Reel / 2500
HT77235SPER	ESOP8 (SPE)	HT77235 YYYMAAB	-40°C ~ 125°C	Tape and Reel / 2500
HT77231STNR	SOT23-6L (STN)	231W	-40°C ~ 125°C	Tape and Reel / 3000

Part Number

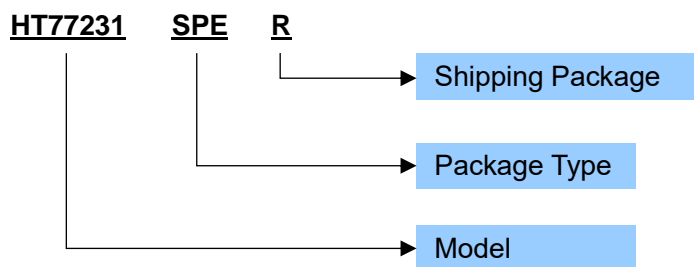

Production Tracking Code

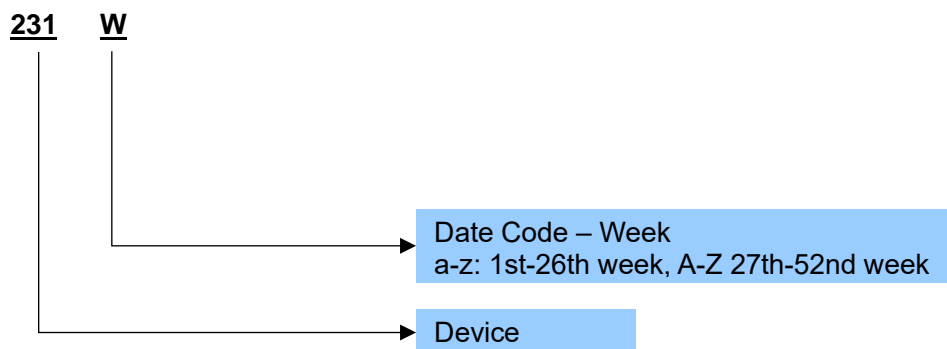
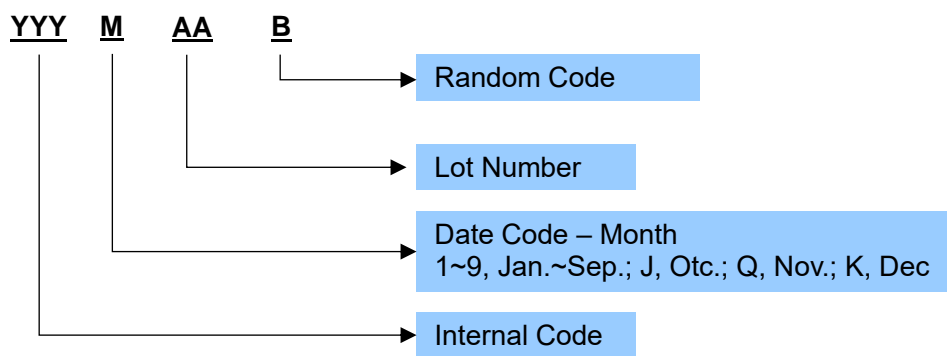

¹ YYYMAAB is production tracking code
Copyright©2025, Heroic Technology

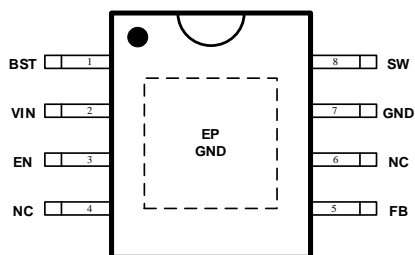
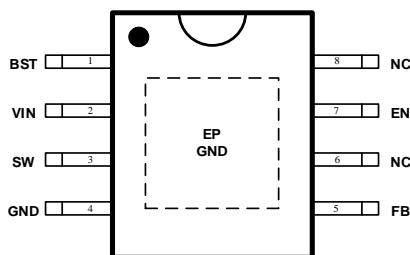
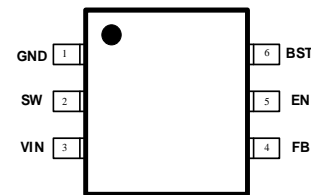
■ TERMINAL CONFIGURATION

HT77231SPER Top View

HT77235SPER Top View

HT77231SNTR Top View
■ TERMINAL FUNCTION

Terminal No.			Name	Description
ESOP8 HT772 31	ESOP8 HT772 35	SOT23 -6L		
1	1	6	BST	Bootstrap. Power supply for the high-side MOSFET driver. Connect a bypass capacitor between BST and SW. BST是内部高端MOSFET驱动器的正电源。在BST和SW之间连接一个旁路电容器。
2	2	3	VIN	Input supply. VIN supplies power to all of the internal control circuitries. A decoupling capacitor to ground must be placed close to VIN to minimize switching spikes. 输入电源。VIN为所有内部控制电路供电。接地滤波电容必须放置在VIN附近，以减少开关尖峰。
3	7	5	EN	Enable input, with internal pull-up current source. Pull EN below the specified threshold to shut down the device. Pull EN above the specified threshold to enable the device. Float to enable. 使能脚，内置上拉电流源。将EN拉到阈值以下以关闭。将EN拉至阈值以上启用。EN脚悬空启用使能。
4, 6	6, 8	--	NC	No connection, connect to GND
5	5	4	FB	Feedback. Connect resistor divider to output voltage. 反馈。接分压电阻到输出电压。
7	4	1	GND	Ground. GND should be placed as close to the output capacitor as possible to avoid the high-current switch paths. 地。GND应尽可能靠近输出电容，以避免高电流开关路径。
8	3	2	SW	Switch node. 开关端口。
EP	EP	--	-	Thermal pad and GND, connect to GND. 散热PAD，同时也是地

IMPORTANT NOTICE**注意**

Heroic Electronic Technology (Jiaxing) Co., Ltd (HT) reserves the right to make corrections, modifications, enhancements, improvements, and other changes to its products and services at any time and to discontinue any products or services. Customers should obtain the latest relevant information before placing orders and should verify that such information is current and complete.

禾润电子科技（嘉兴）股份有限公司（以下简称HT）保留对产品、服务、文档的任何修改、更正、提高、改善和其他改变，或停止提供任何产品和服务的权利。客户在下单和生产前应确保所得到的信息是最新、最完整的。

HT assumes no liability for applications assistance or customer product design. Customers are responsible for their products and applications using HT components.

HT对相关应用的说明和协助以及客户产品的板级设计不承担任何责任。

HT products are not authorized for use in safety-critical applications (such as life support devices or systems) where a failure of the HT product would reasonably be expected to affect the safety or effectiveness of that devices or systems.

HT的产品并未授权用于诸如生命维持设备等安全性极高的应用中。

The information included herein is believed to be accurate and reliable. However, HT assumes no responsibility for its use; nor for any infringement of patents or other rights of third parties which may result from its use.

本文中的相关信息是精确和可靠的，但HT并不对其负责，也不对任何可能的专利和第三方权利的侵害负责。

Following are URLs and contacts where you can obtain information or supports on any HT products and application solutions:

下面是可以联系到我公司的相关链接和联系方式：

禾润电子科技（嘉兴）股份有限公司**Heroic Electronic Technology (Jiaxing) Co., Ltd.**

地址：浙江省嘉兴市南湖区亚太路906号科创CBD园区21号楼11层

Add: 11th floor, Building 21, No. 906, Yatai Road, Jiaxing, Zhejiang Province

Sales: 0573-82586608, sales@heroic.com.cn

Support: 0573-82586151, support@heroic.com.cn

Website: www.heroic.com.cn; wap.heroic.com.cn

Wechat MP: HEROIC_JX

请及时关注禾润官方微信公众号，随时获取最新产品信息和技术资料！

